



+ **OUT'ACCES**

▶ Retráctiles

Las gradas retráctiles son ideales para aprovechar al máximo el espacio en los gimnasios escolares y en estadios techados.

Cada módulo cuenta con barandales laterales para mayor seguridad y pasillo intermedio.

Los respaldos son abatibles para que las gradas puedan plegarse con facilidad.

Contamos con:

▶ GRADAS DE PARED



▶ GRADAS EMPOTRABLES



▶ UNIDADES PORTABLES





Modelo: YY-LN-P

Material: Hope

Técnica de procesamiento: moldeo por soplado

Sistema de gradas: Gradas telescópicas,

Condiciones: Interior

Ancho de fila: 700 mm

Altura de fila: 250 mm

Asiento C/C: 452 mm

Control de movimiento: control eléctrico o manual

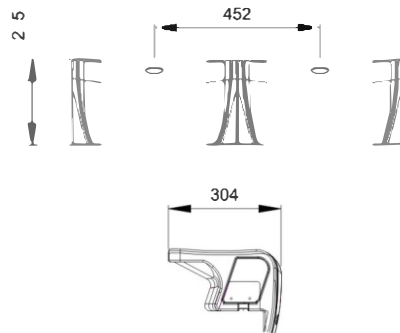

700mm 700mm 700mm 700mm 700mm 450mm

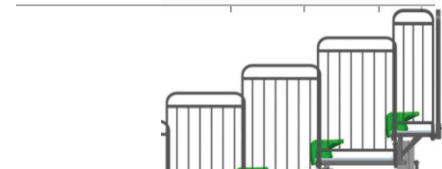

250mm
250mm
250mm
250mm
250mm
350mm



1150mm





Modelo: YY-XT-P
 Material: Hope
 Técnica de procesamiento: moldeo por soplado
 Sistema de gradas: Gradas telescópicas,
 Condiciones: Interior
 Ancho de fila: 800 mm
 Altura de fila: 300 mm
 Asiento C/C: 460 mm
 Control de movimiento: control eléctrico o manual

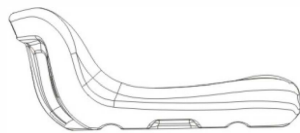

410mm

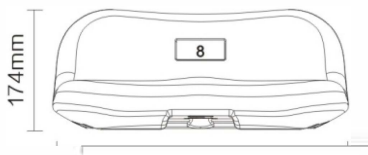

174mm

418mm

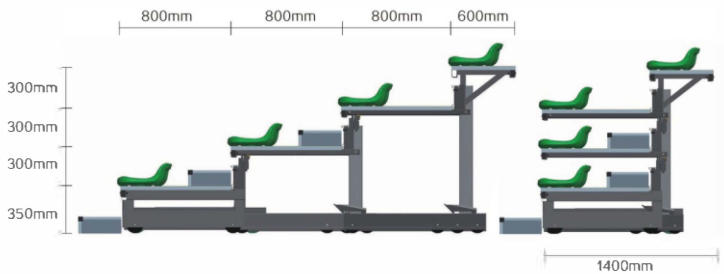

Asiento delantero plegable



Modelo: YY-FT-P
 Material: HOPE
 Técnica de procesamiento: moldeo por soplado
 Sistema de soporte: gradas telescópicas
 Condiciones: interior

Ancho de fila: 850 mm
 Altura de fila: 300mm
 Asiento C/C: 460mm

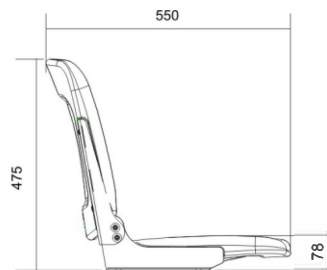

YY-FT-R

YY-FT-P

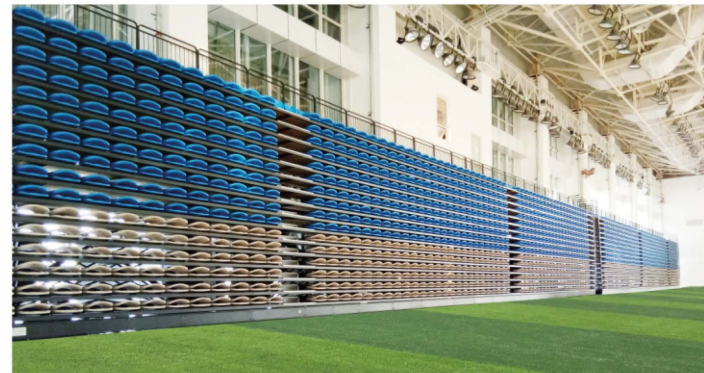
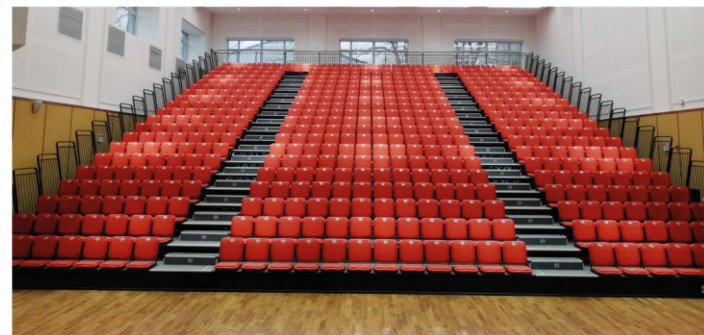

Asiento trasero plegable



Modelo: YY-FT-P
 Material: HOPE
 Técnica de procesamiento: moldeo por soplado
 Sistema de soporte: gradas telescópicas
 Condiciones: interior
 Ancho de hilera: 850 mm
 Altura de fila: 300 mm
 Asiento C/C: 480 mm

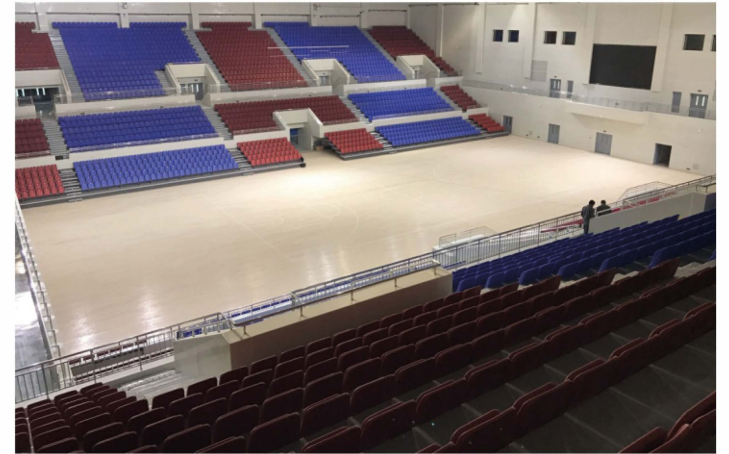
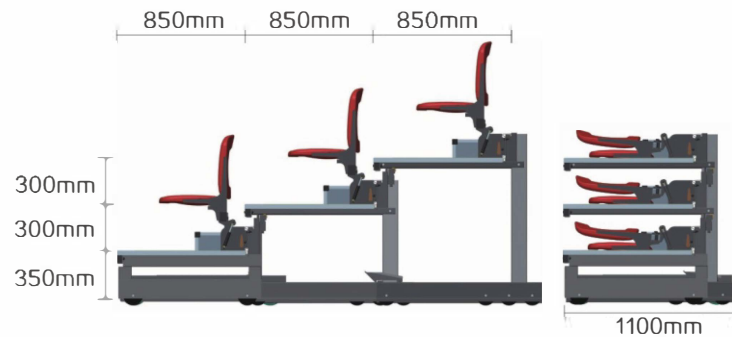
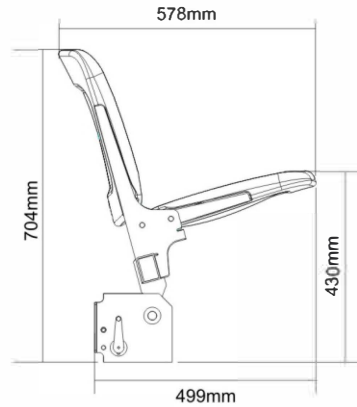

Asiento delantero plegable



Modelo: YY-ZT-P
 Material: polipropileno.
 Técnica de procesamiento: Asistido por gas
 Sistema de gradas: asientos de estadio, gradas telescópicas
 Técnica de procesamiento: asistido por gas
 Ancho de fila: 850 mm
 Altura de fila: 300 mm
 Asiento C/C: 480-520 mm

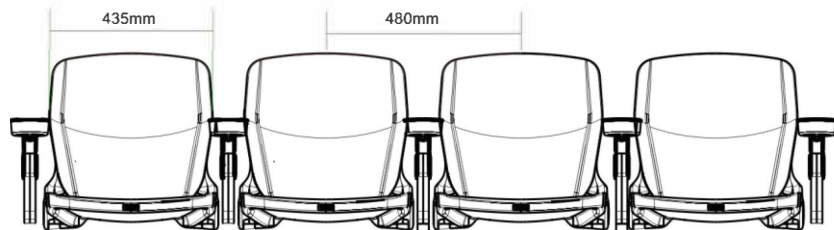
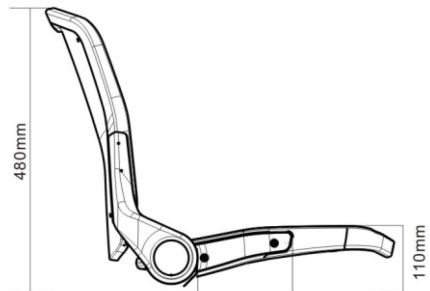

Asiento trasero plegable

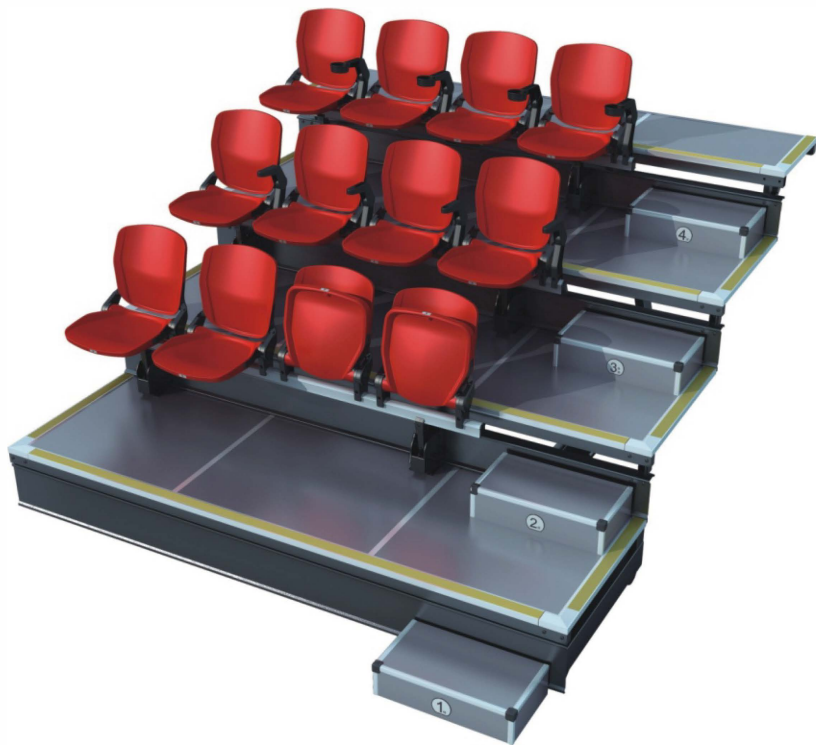

Modelo: YY-ZT-P
 Material: polipropileno.
 Técnica de procesamiento: Sistema de soporte de moldeo por soplado: Gradas telescópicas, Condiciones: Interior
 Ancho de fila: 850 mm
 Altura de fila: 300 mm
 Asiento C/C: 480-520 mm

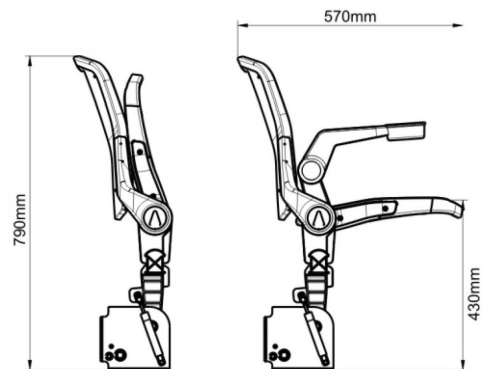

Modelo: YY-QY-R

Asiento trasero plegable



Modelo: YY-QY-R
 Técnica de procesamiento: silla tapizada
 Sistema de soporte: gradas telescópicas, ancho de fila: 900 mm
 Altura de fila: 300 mm
 Asiento C/C: 510 mm

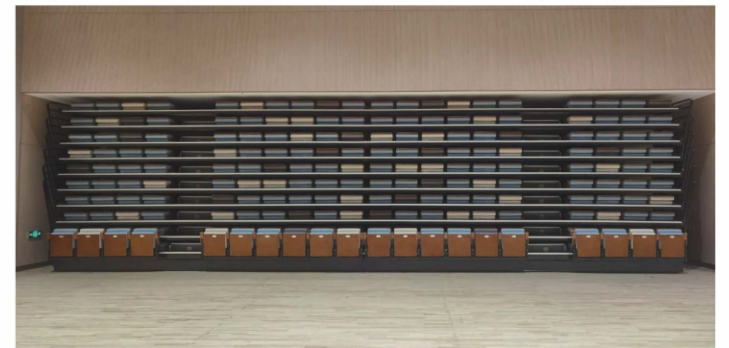
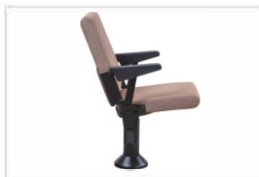
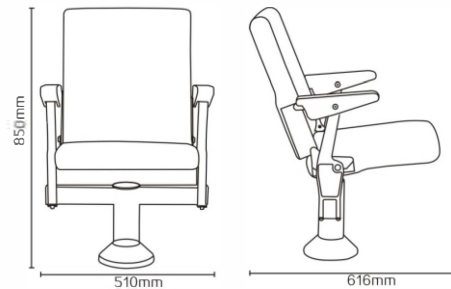

Asiento trasero plegable

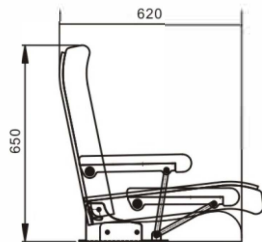
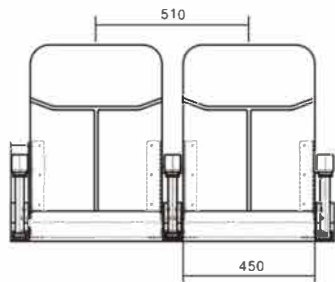

Modelo: YY-SK-R

Técnica de procesamiento: silla

tapizada Sistema de soporte: gradas

telescopicas, ancho de fila: 900 mm

Altura de fila: 300 mm

Asiento C/C: 510 mm

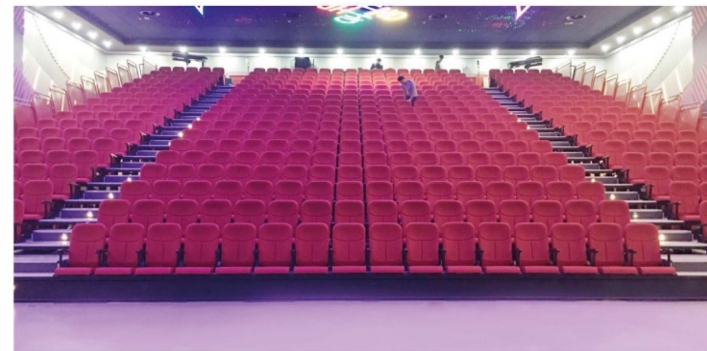
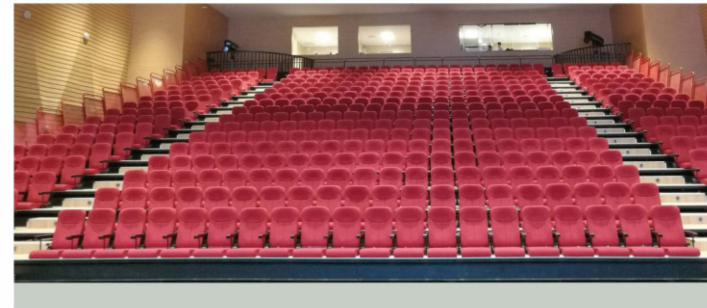

(Asiento delantero plegable)



Modelo: YY-GB-R
 Material: Q235 Steel+Sponge
 Técnica de procesamiento: Silla tapizada
 Sistema de soporte: Telescópico, gradas cilíndricas
 Condiciones: Interior
 Ancho de fila: 850 mm
 Altura de fila: 300 mm
 Asiento C/C: 500 mm

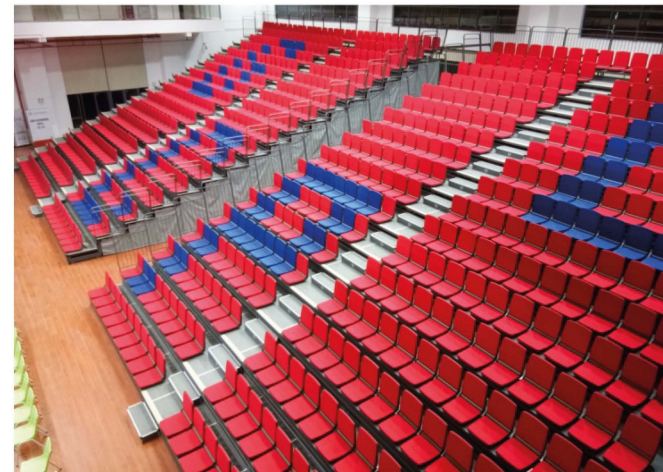
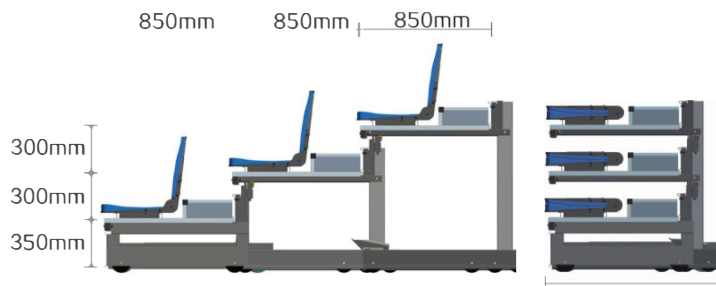
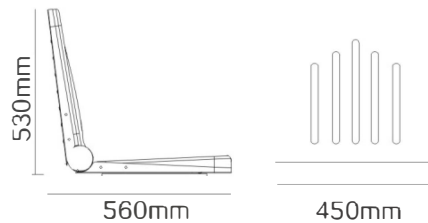

1150mm